



Illuminating Global Education Through Indianic Values

NEW STANDARD GROUP OF INSTITUTES



**HOME
ASSIGNMENT
2024**

Name.....

Class. Nursery.....Sec.

Branch.....

HINDI

1- बिन्दु से बिन्दु मिलाते हुए अर्धवृत्त रेखा खींचिए—

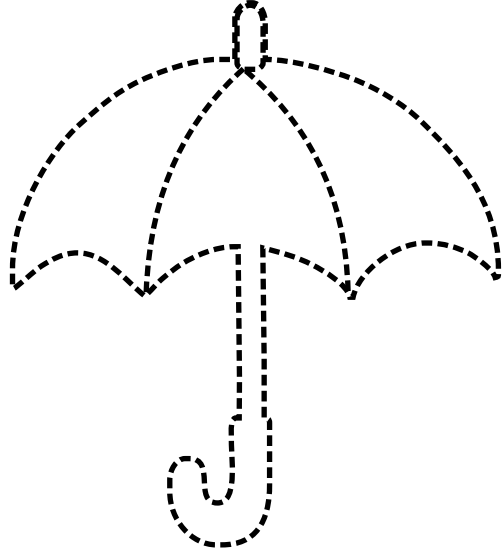

.
.
.
.
.
.
.
.

2- पढ़िए और लिखिए –

उ

उ

ऊ

ऊ

3- "ऊ" अक्षर और दिए गए चित्र में रंग भरिए—

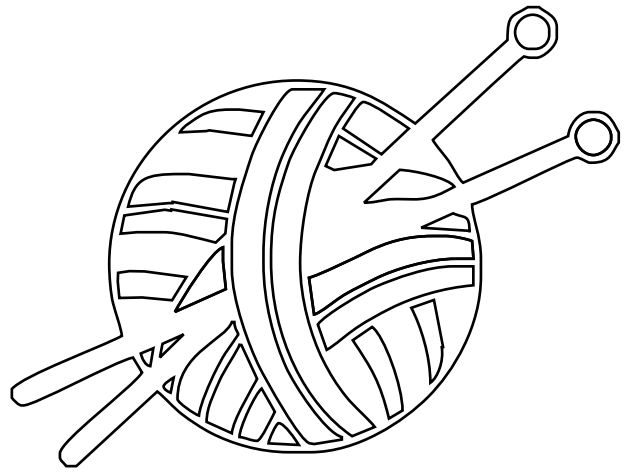
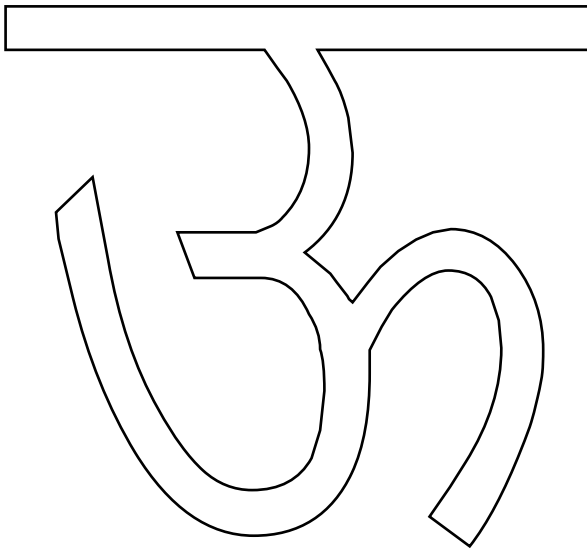

ऊन

(P.T.O)

ENGLISH

1- Trace and colour the picture:

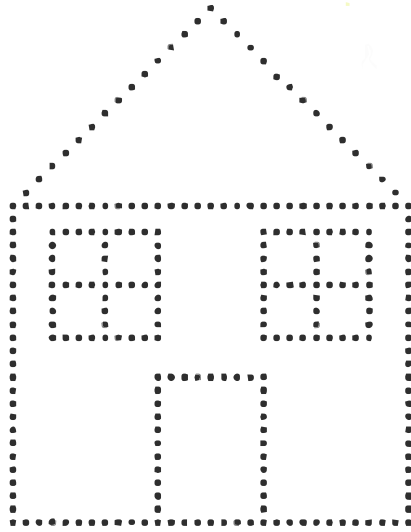

2- Trace the standing lines and colour the picture.

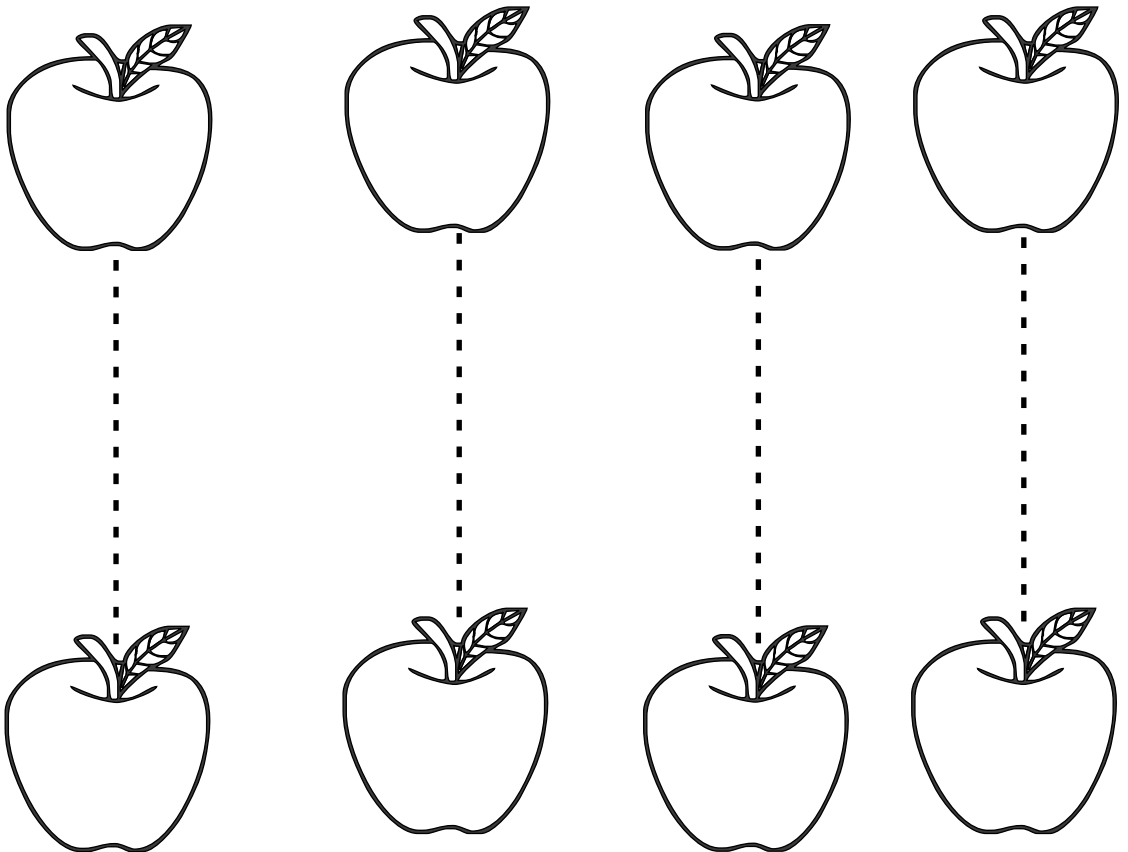

3- Trace the sleeping lines and colour the picture.

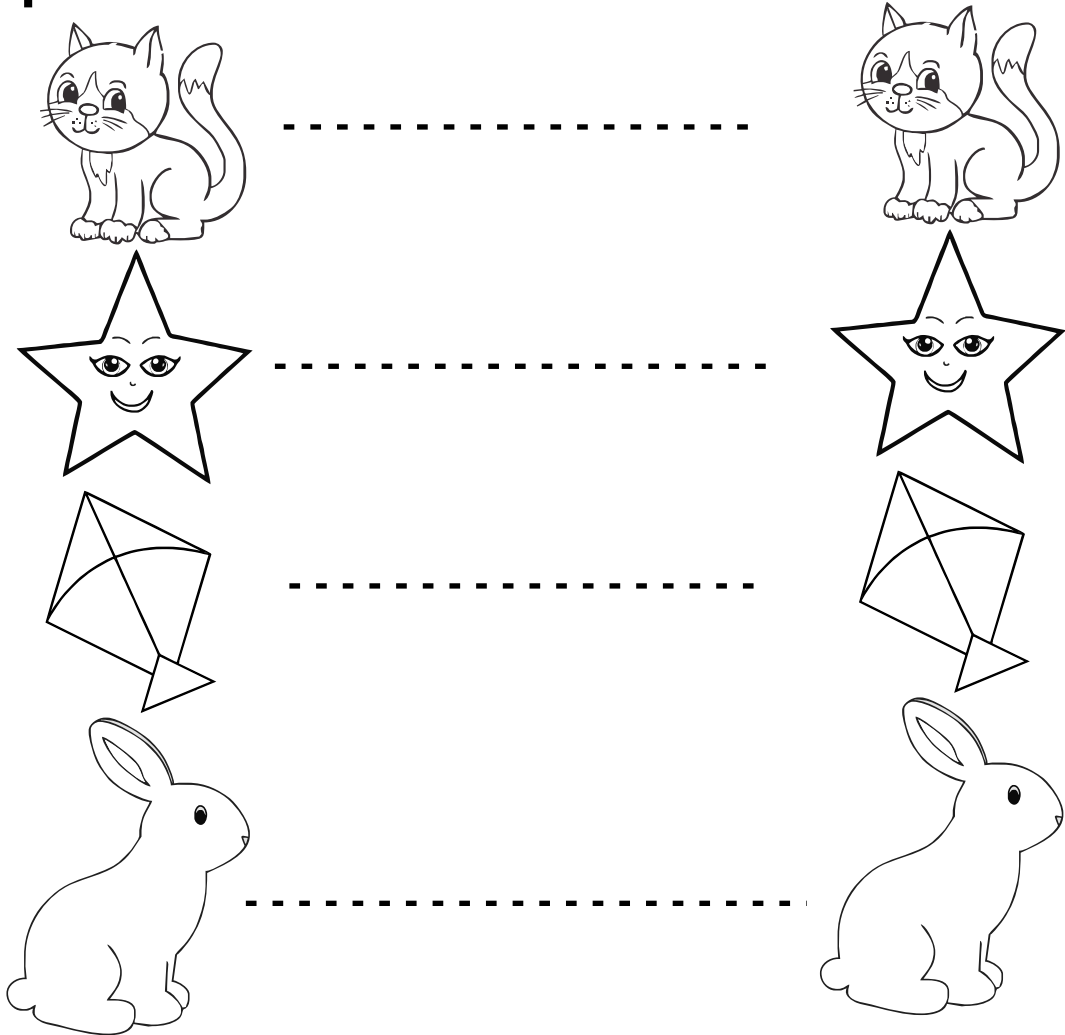

4- Circle the pictures which begins from the given letter.

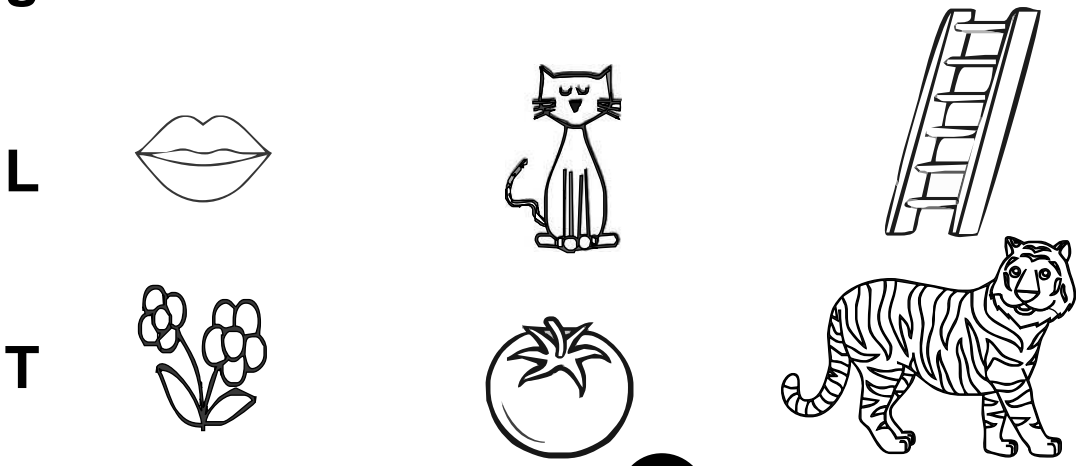

(P.T.O)

5- Look and write :-

L

L

T

T

MATHS

1- Trace and colour the picture:

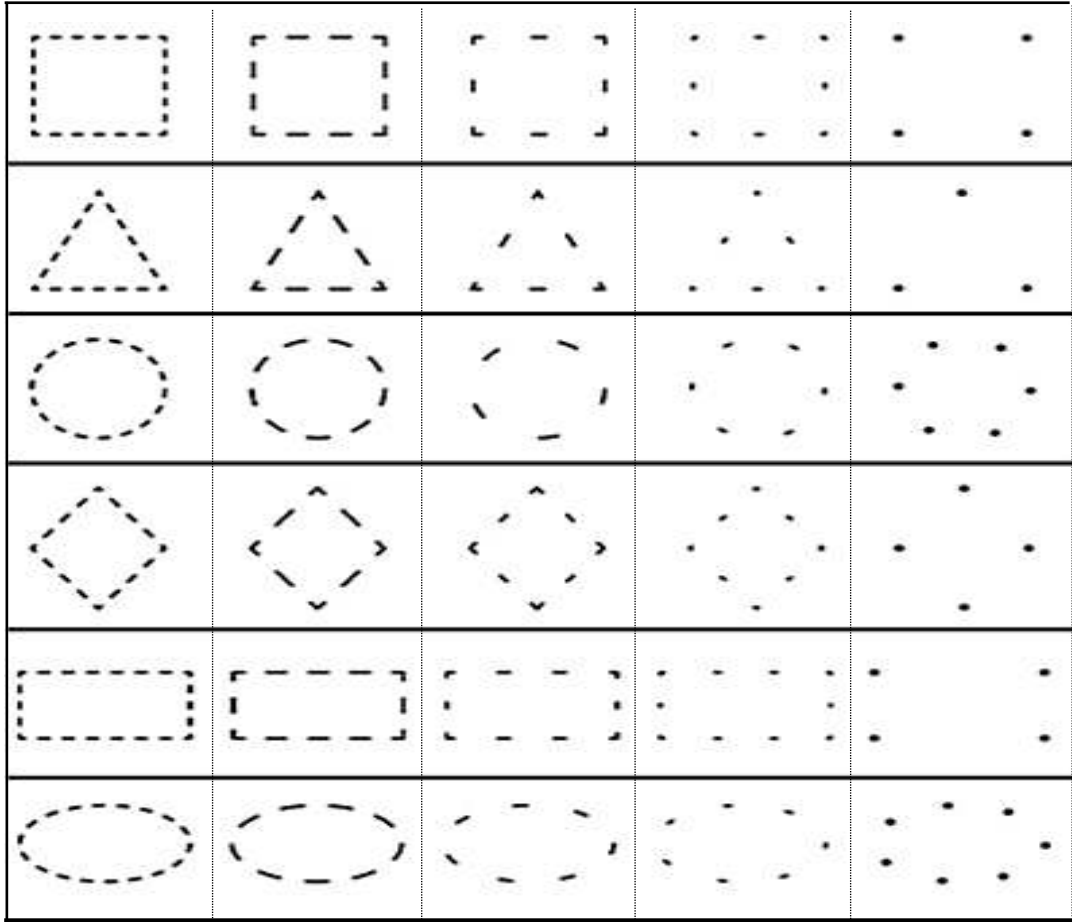

2- Circle the smaller object.

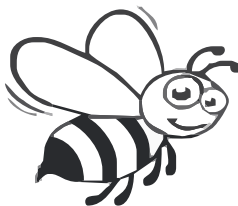
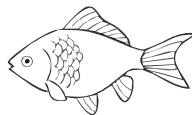
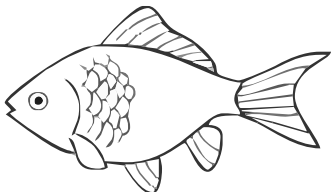
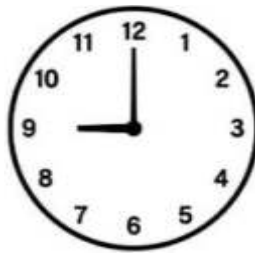

(P.T.O)

3- Look and write :-

0

1

4

7

ART

1- Trace the dots and make a Mango then colour it.

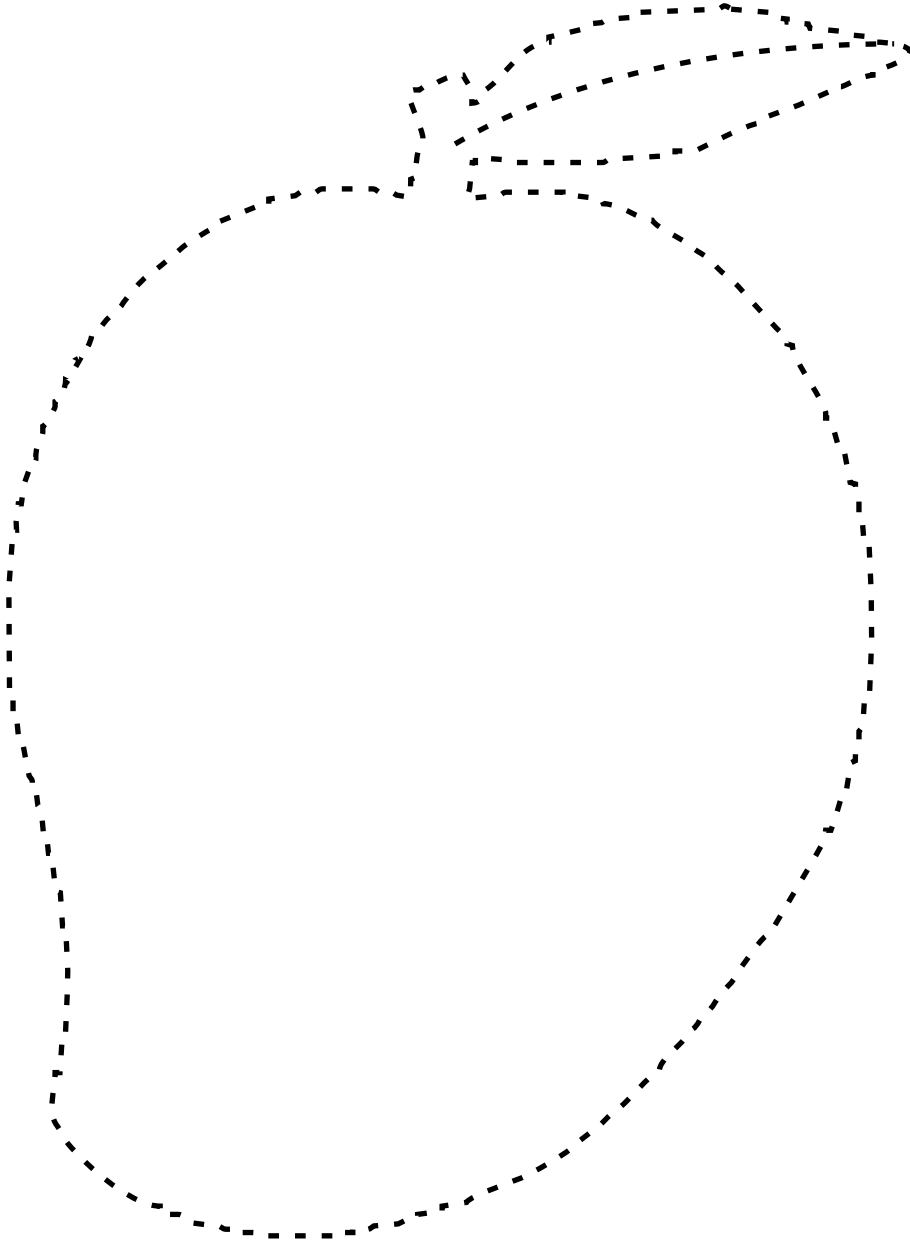

M A N G O

(P.T.O)

2- Colour the picture:

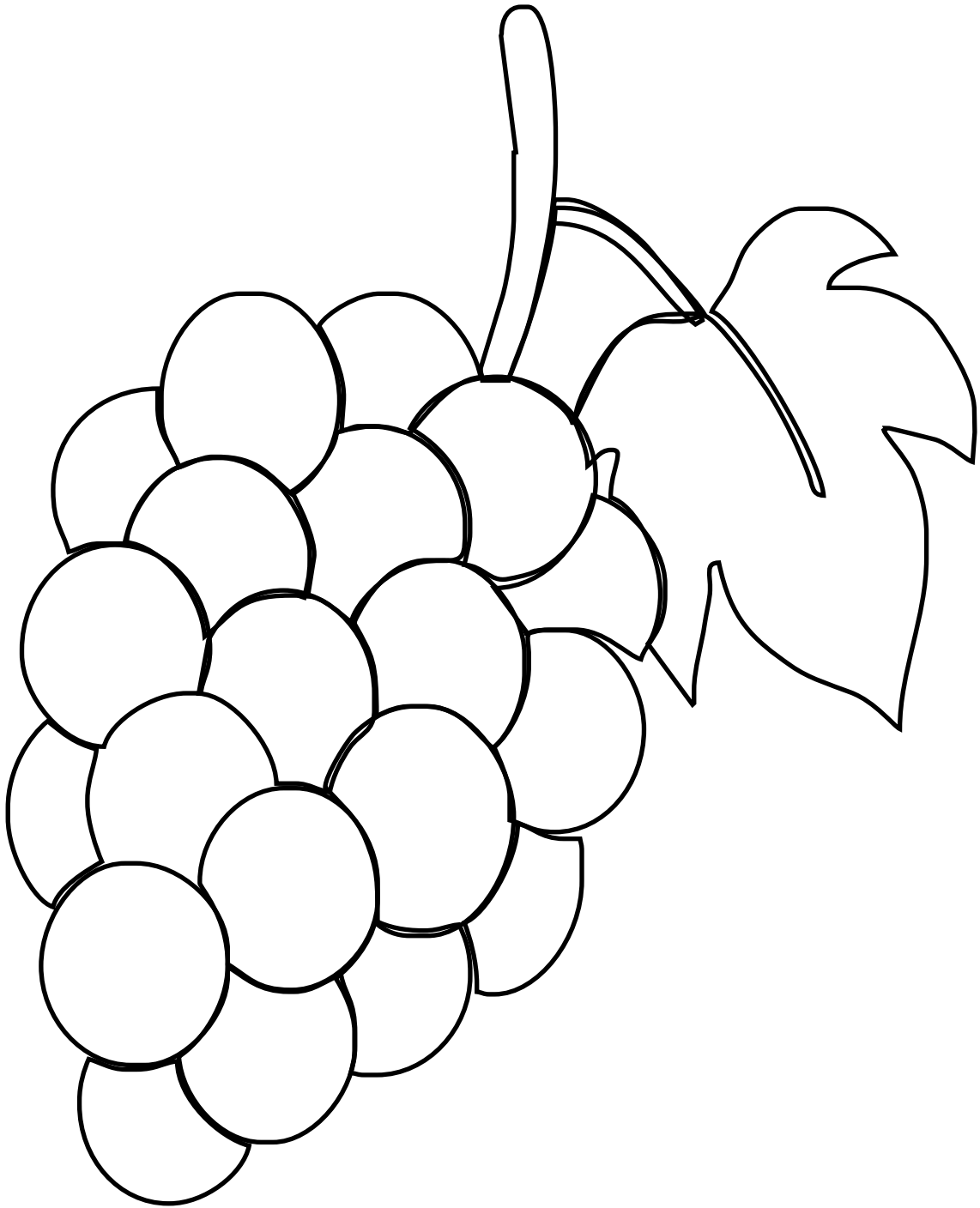

3- Paste the picture of your father on the face of super hero and colour the picture.

HAPPY FATHER'S DAY

DAD,

*YOU ARE MY
SUPERHERO*

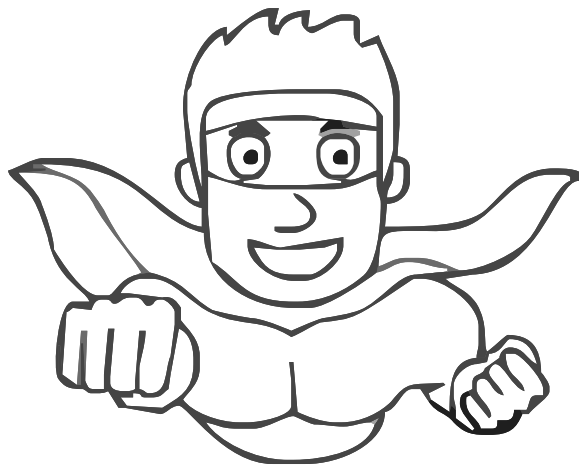

(P.T.O)

Conversation

Q.1- What is your name ?

Ans. My name is _____.

Q.2- How old are you ?

Ans. I am _____years old.

Q.3- What is your father's name ?

Ans. My father's name is Mr. _____.

Q.4- What is your mother's name ?

Ans. My mother's name is Mrs. _____.

Q.5- Where do you live?

Ans. I live in _____.

(English Rhyme)

Chubby cheeks, dimple chin

Rosy lips, teeth within

Curly hair, very fair

Eyes are blue, lovely too

Teacher's pet, is that you ?

Yes! Yes! Yes!

हिन्दी कविता

बिस्कुट का पेड़

मेरी प्यारी अच्छी नानी,

सुनाओ ऐसी एक कहानी ।

जिसमें हो बिस्कुट के पेड़,

हो चॉकलेट, टॉफी के ढेर ।

पापा जब दफ्तर से आएँ,

खूब खिलौने संग में लाएँ ।

मेरी प्यारी अच्छी नानी,

हमें सुनाओ एक कहानी ।।